

VMS MF - VMSA MF 100 - 240

PRODUCT LABEL

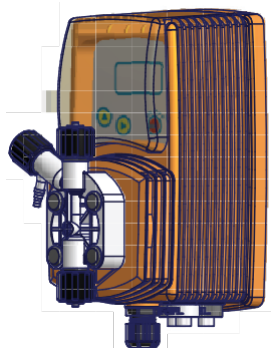

VMS MF

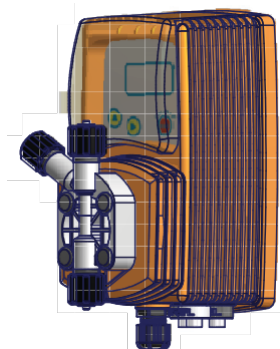

VMSA MF

SOLENOID-DRIVEN DIAPHRAGM
DOSING PUMP

EN



OPERATING MANUAL



This manual contains important SAFETY information regarding the installation and operation of the device.

Read and keep for future reference.

Carefully follow this information to prevent personal injury and property damage.

The information in this manual may contain inaccuracies or typographical errors. The information contained in this manual is subject to change at any time without notice.

Version: R3-02-24



NORME CE
EC RULES (STANDARD EC)
NORMAS DE LA CE

Direttiva Basso Voltaggio
Low Voltage Directive
Directiva de baja tensión

} **2014/35/EU**

Direttiva EMC Compatibilità Elettromagnetica
EMC electromagnetic compatibility directive
EMC directiva de compatibilidad electromagnética

} **2014/30/EU**

Norme armonizzate europee nell'ambito della direttiva
European harmonized standards underdirective
Las normas europeas armonizadas conforme a la directiva

} **2006/42/EC**

GENERAL NOTES ON SAFETY

During installation, testing and inspection it is mandatory to comply with the following management and safety instructions.

SYMBOLS

The following symbols are used in this document. Familiarise yourself with the symbols and their meanings before proceeding with the installation or use of this tool.



Danger!

Indicates a potential hazard which could result in death or serious injury to persons if not avoided.



Caution!

Indicates a potential hazard which could result in minor injury to persons and/or damage to property if not avoided.

Both indicate important information to be observed in any case.



Important! - Indicates a potentially dangerous situation which may result in an undesirable outcome or state if not avoided. A practice unrelated to personal injury.



Cross-reference - This symbol indicates a reference to a specific page or paragraph in the manual.

**PURPOSE OF USE
AND SAFETY
WARNINGS**

EQUIPMENT INTENDED FOR DRINKING WATER TREATMENT

The pump must only be used for dosing liquid products.

It must not be used in explosive environments (EX).

It must not be used to dose flammable chemicals.

It must not be used with radioactive chemical material.

Only use the pump after installation.

Use the pump in accordance with the data and technical specifications on the label.

Do not modify or use it in any other way than specified in the operating manual.



Keep the pump protected from sun and rain. Avoid splashing water.



During an emergency of any kind in the room where the pump is installed, immediately cut off the power to the system and disconnect the pump from the power socket.



If particularly aggressive chemical materials are used, regulations on the use and storage of these substances must be strictly followed.



Always observe local safety regulations.



The dosing pump manufacturer cannot be held liable for damage to persons or property caused by improper installation, misuse or incorrect use of the dosing pump!



Install the dosing pump so that it is easily accessible whenever maintenance is required.

Do not obstruct the location of the dosing pump!



The device must be connected to an external control system. In the event of a water shortage, dosing must be stopped.



Service and maintenance of the dosing pump and all its accessories must always be carried out by qualified personnel.



Before any installation and maintenance work:

- Carefully read the chemical characteristics of the product to be dosed and refer to the product's safety data sheet;
- Wear suitable SAFETY DEVICES;
- Drain the dosing pump connection pipes;
- Carefully wash any hoses that have been used with particularly aggressive chemical materials.

**ENVIRONMENTAL
SAFETY**

Work area

Always keep the area where the pump is installed clean to avoid and/or detect emissions.

Recycling instructions

CER RECYCLING CODE: 16 02 14

Always recycle materials according to the following instructions:

1. Follow local laws and regulations regarding recycling if the unit or certain parts are accepted by an authorised recycling company.
2. If the unit or parts are not accepted by an authorised recycling company, return them to the nearest representative.

Waste and emission regulations

Comply with these safety regulations concerning waste substances and emissions:

- Dispose of all waste properly.
- Treat and dispose of pumped liquid in accordance with applicable environmental regulations.
- Clean up all liquid spills in accordance with environmental and safety procedures.
- Report all environmental emissions to the appropriate authorities.

LABEL

Data

CODE: pump code

MODEL: pump model

PUMP DATA

S/N (serial number)

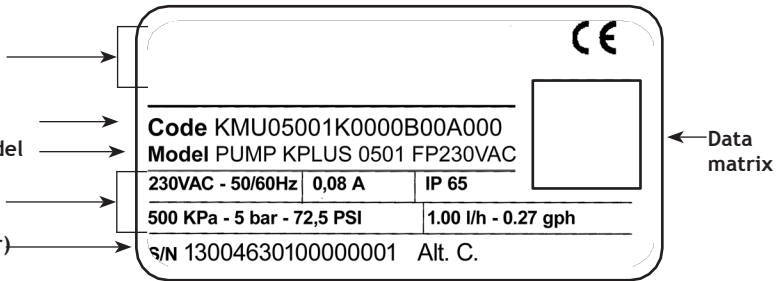

(example)

Spare parts

Please refer to the pump label when ordering spare parts or in general for communications.

In particular, the code (CODE) and the serial number (S/N) uniquely identify the pump in question.

**FIRST
START-UP**

When switching the dosing pump on for the first time or after a reset to factory settings, the system language must be chosen from those available.

TRANSPORT AND STORAGE

i The pump may become damaged by unsuitable transport or storage.

Store and transport the pump properly packed, preferably in its original packaging.

Observe the storage conditions for transport as well.

Even if packed, always protect the device from moisture and the action of chemicals.

⚠ Before returning the pump to the service department, remove all liquid inside the pump body and dry it **BEFORE** packing it in its original box. Follow the procedure described in  Stop procedure.

After emptying the pump body, if there is still a chance that any highly corrosive liquid may cause damage, this must be declared on the REPAIR REPORT form.

i DO NOT DISCARD PACKAGING. REUSE IT FOR TRANSPORT.

Packaging and transporting temperature10 to 50°C (32 to 122°F)
Atmospheric humidity95% relative humidity (non-condensing)

INTRODUCTION

VMS MF series

VMS MF is the multifunctional series because it allows different working modes to be set: Constant, Divide, Multiply, ppm, perc, mlq, batch, volt, mA, Timer. In addition, you can:

- set an upkeep dosing in case of system downtime (ppm menu - upkeep setting)

The pump is equipped with:

- LEVEL input (level control)

Pump dosing is determined by the number of pulses and the capacity per single injection. Single injection adjustment is linear only over values between 30% and 100%.

The operating and control parameters are shown on an LCD display and managed via a keypad.



Some features described in this manual may require the use of additional accessories (not included).

VMSA MF series

The VMSA MF dosing pump is the **self-purging pump body** version of the VMS MF pump. The use of a self-purging pump body is necessary for dosing gas-generating chemicals (e.g. hydrogen peroxide, ammonia, sodium hypochlorite at certain temperatures).

For installation  "Connecting hydraulic components on self-purging mod. VMSA MF".

Package contents

4	dowels ø6
4	self-tapping screws 4.5 x 40
1	delay fuse 5 X 20
1	level probe with axial foot filter (PVDF)
1	injection valve (PVDF) calibrated to 0.3 bar
2 m	delivery hose* (matt PE)
2 m	suction hose* (PVC)
2 m	bleed hose (clear PVC 4x6)
1	operating manual

* If the measurement is 6x8, there is only one 4-metre opaque hose. Cut to obtain the two hoses.

Fig. 1. VMS MF - VMSA MF pump

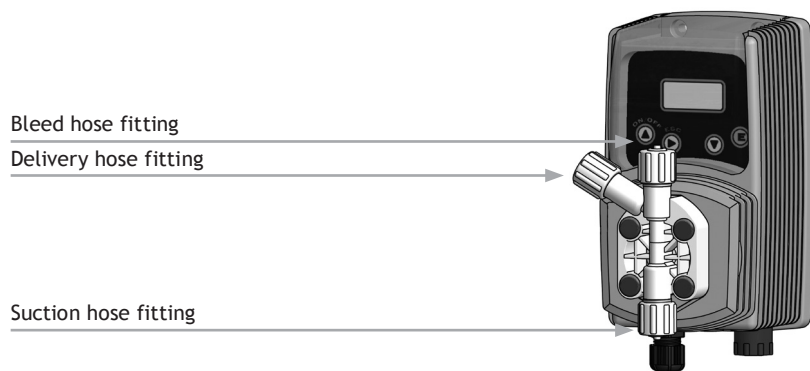
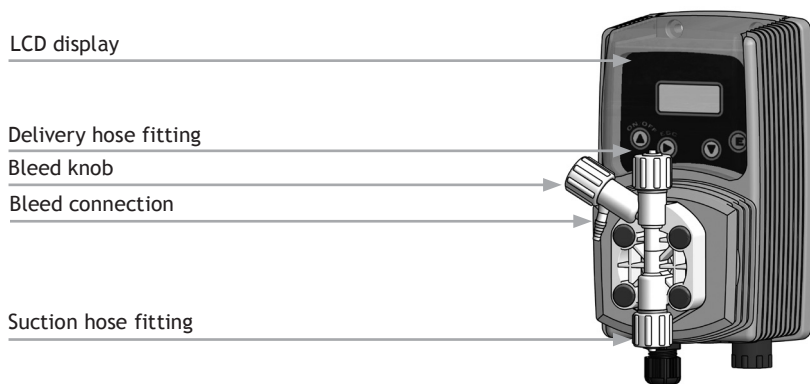

**Technical
and electrical
specifications**

POWER SUPPLY	FREQ.
230 VAC (180-270 VAC)	50/60 Hz
115 VAC (90-135 VAC)	50/60 Hz
24 VAC (20-32 VAC)	50/60 Hz
12 VDC (10-16 VDC)	

Number of injections per minute 0 - 180
 Max Suction hose height 1.5 metres

Room temperature for operation 0 - 45 °C (32 - 113 °F)
 Additive temperature: 0 - 50 °C (32 - 122 °F)
 Transporting and packaging temperature: -10 - 50 °C (14 - 122 °F)

Altitude 2000 m
 Installation Class: II
 Level of pollution: 2

Audible noise: VMS/VMSA: 70.4 db(A);
 silenced VMS/VMSA: 67.4 db(A);
 ultra-silenced VMS/VMSA: 66.4 db(A);

Degree of protection: VMS / VMSA: IP 65

FUSE VALUES	
Solenoid diam.	100 - 240 VAC
60	800mA
70	
80	

Table 1. VMS MF and VMSA MF model information

VMS MF						
	FLOW RATE			cc per pulse	Maximum pressure	
	min cc/h	max l/h	Max GPH		bar	PSI
	2001	0.09	1			
1802	0.19	2	0.53	0.19	18	261
1804	0.37	4	1.06	0.37	18	261
1502	0.19	2	0.53	0.19	15	217
1504	0.37	4	1.06	0.37	15	217
1505	0.46	5	1.32	0.46	15	217
1004	0.37	4	1.06	0.37	10	145
1005	0.46	5	1.32	0.46	10	145
1010	0.93	10	2.64	0.93	10	145
0706	0.56	6	1.58	0.56	7	101
0510	0.93	10	2.64	0.93	5	72
0512	1.11	12	3.17	1.11	5	72
0501	0.09	1	0.26	0.09	5	72
0408	0.74	8	2.11	0.74	4	58
0310	0.93	10	2.64	0.93	3	43
0215	1.39	15	3.96	1.39	2	29
0116	1.48	16	4.23	1.48	1	14

VMSA MF						
	FLOW RATE			cc per pulse	Maximum pressure	
	min cc/h	max l/h	Max GPH		bar	PSI
	1802	0.19	2			
1503	0.28	3	0.79	0.28	18	217
1501	0.09	1	0.26	0.09	15	217
103.4	0.31	3.4	0.9	0.31	10	145
1007	0.65	7	1.85	0.65	10	145
1002	0.19	2	0.53	0.19	10	145
0704	0.37	4	1.06	0.37	7	101
057.5	0.69	7.5	1.98	0.69	5	72
0509	0.83	9	2.38	0.83	5	72
045.5	0.51	5.5	1.45	0.51	4	58
0307	0.65	7	1.85	0.65	3	43
0212	1.11	12	3.17	1.11	2	29
0113.5	1.25	13.5	3.57	1.25	1	14

Manufacturing materials

✓ : standard
X : option available

	PVDF	PP	PPV0	PMMA	PVC	PE	CE	GLASS	PTFE	SS	VITON®	EPDM	WAX	SI
BOX		✓	X											
PUMP BODY	✓	X												
DIAPHRAGM									✓					
BALLS							✓	X	X	X				
SUCTION HOSE	X				✓	X								
DELIVERY HOSE	X				X	✓								
BLEED HOSE	X				✓	X								
O-RING									X		X	X	X	X
LEVEL PROBE / FOOT FILTER	✓													
LEVEL PROBE CABLE						✓								

Default parameters

	At first start-up	After the LOAD DEFAULT procedure
PASSWORD	0000	0000
WORKING MODE	mA	CONSTANT
	High mA 20.0: spm 180	100 SPM
	Low mA 0: spm 0	-
CS/ST	Depending on the flow rate (Table 1 and 2. cc per pulse)	0
UNIT	litres	litres
TIMEOUT	120 seconds	0
OUT ALARM*	Enabled N.C. (normally closed)	Enabled N.C. (normally closed)

*feature available only with software version 1.4.5i

INSTALLATION

Installing the dosing pump

Installation and commissioning takes place in 5 phases:

1. Pump positioning
2. Hydraulic connection (hoses, level probe, injection valve)
3. Electrical connection
4. Priming
5. Programming

Before installation, check that all necessary precautions have been taken for the safety of the installer.

⚠ ALWAYS wear protective masks, gloves, safety goggles and if necessary additional PPE during all installation phases and while handling chemicals!

⚠ Avoid splashing water and direct sunlight!

Pump positioning

Secure the pump on a stable support at a maximum height of **1.5 m** above the bottom of the container.

! The injection point must be higher than the storage container in order to avoid accidental product spillage.

If this is not possible, a **multifunction valve** must be mounted on the delivery side of the dosing pump to prevent accidental chemical input.

! Install the pump

- in a safe place and secure it so that the vibrations produced during its operation do not cause any movement;
- in an easily accessible place;
- with the base in a horizontal position:

! Use only hoses compatible with the chemical to be dosed. Refer to the  Chemical compatibility table. If the product is not in the table, consult the supplier.

Fig. 2. Installing the dosing pump

- 1 - Dosing Pump
- 2 - Suction Hose
- 3 - Delivery Hose
- 4 - Injection Valve
- 5 - Air Discharge
- 6 - Level probe
- 7 - Foot filter
- 8 - Power supply

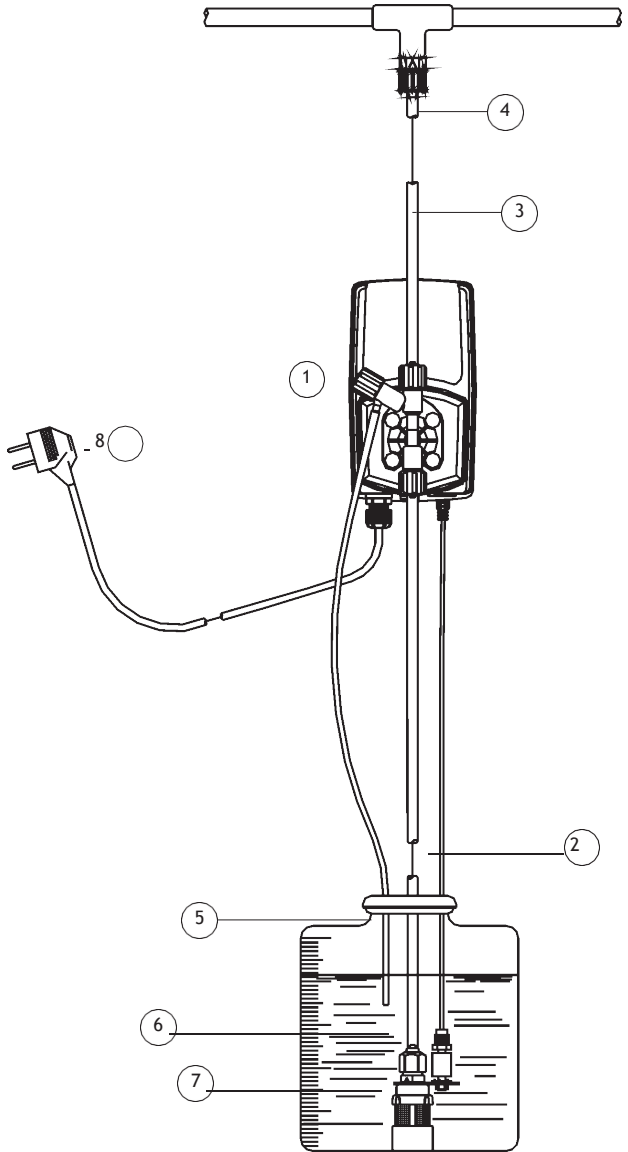

HYDRAULIC CONNECTION

Level probe

The level probe is supplied already assembled and is equipped with a foot filter that prevents sediment from being sucked in. Place the level probe on the bottom of the container. Connect the BNC on the level probe to the level probe input on the pump.

 If there is a mixer in the container, a suction lance must be installed.

Follow the diagram below when replacing parts on the level probe.

Fig. 3. Foot filter / level probe assembly

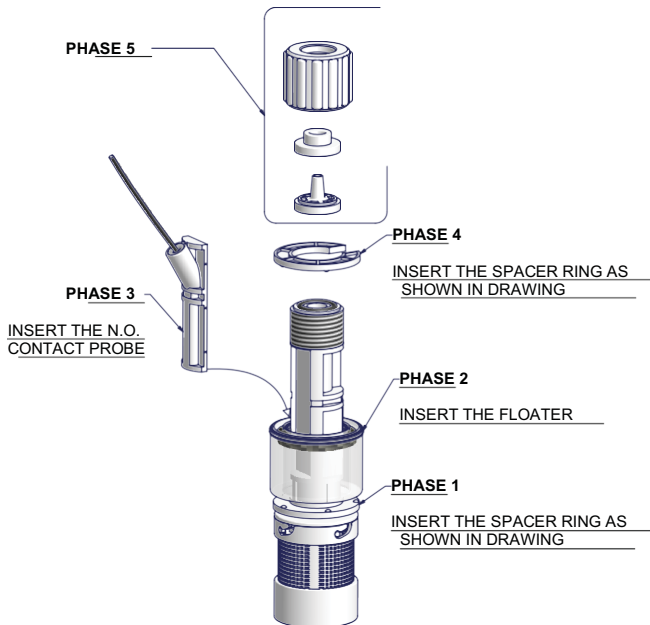

Suction hose /
foot filter
connection

⚠ The suction hose must be as short as possible and installed in a vertical position to prevent the suction of air bubbles!

Completely unscrew the suction ring on the pump body and remove the components required for assembly with the hose: fixing ring, hose lock, hose holder.

Assemble as shown in Figure 5.

Insert the hose all the way into the hose holder.

Tighten the hose on the pump body by screwing the ring nut **using only the strength of your hands alone**.

Connect the other end of the hose to the foot filter using the same procedure.

Fig. 4. Suction hose / pump body assembly

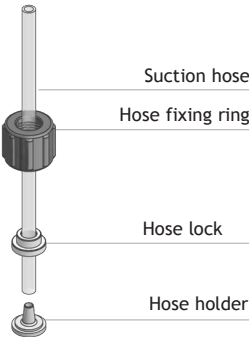

Delivery hose /
pump body
assembly

⚠ The suction and delivery valves must always be in the VERTICAL position.
All hose connections to the pump must be made using only the strength of your hands alone.

⚠ Do not use tools to tighten the rings.
⚠ The delivery hose must be secured so that it cannot produce sudden movements that could cause it to break or damage nearby objects!

Completely unscrew the ring on the pump body and remove the components required for assembly with the hose: fixing ring, hose lock, hose holder.

Assemble as shown in Figure 6.

Insert the hose all the way into the hose holder.

Fig. 5. Delivery hose / pump body assembly

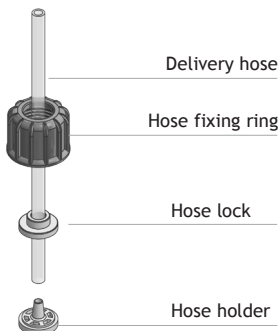

Tighten the hose on the pump body by screwing the ring nut **using only the strength of your hands alone**.

Connect the other end of the hose to the injection valve using the same procedure.

Injection valve

The injection valve must be installed on the system at the water inlet point. The injection valve opens at pressures above 0.3 bar. Valves calibrated to 1, 2, 3, 4 or 5 bar with corresponding connections are available on request.

Bleed hose

Insert one end of the bleed hose onto the bleed hose connection as shown in the figure (C).

Place the other end directly into the tank containing the product to be dosed. In this way the liquid leaked out during the priming phase will be fed back into the tank.

Fig. 6. Description of pump body with manual bleed (VMS MF)

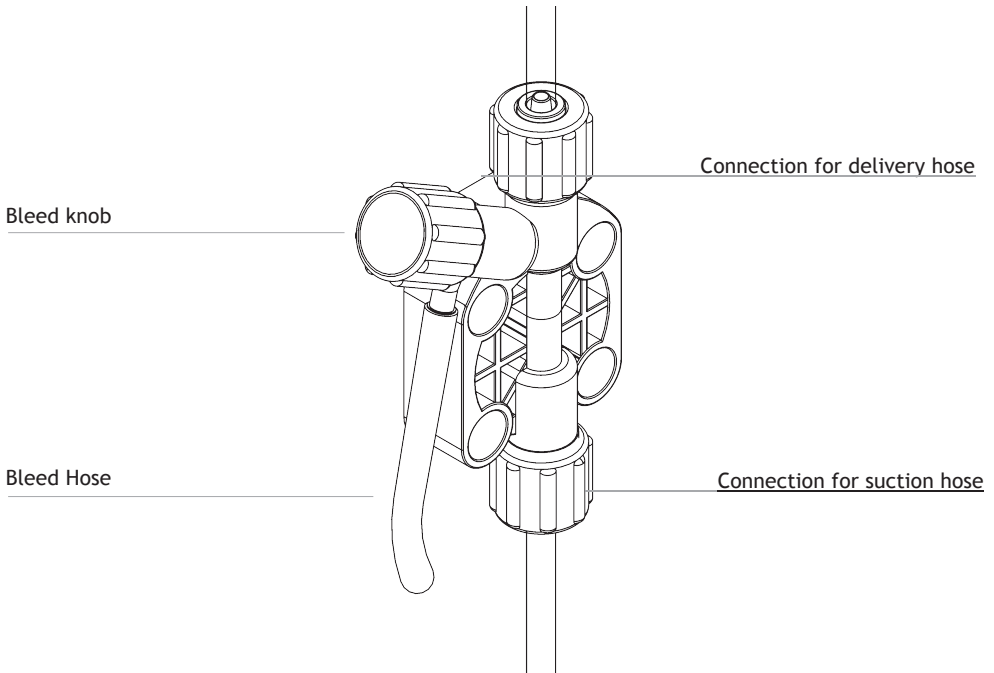

The manual bleed procedure is described in **How to prime the pump**.

Bending the bleed hose slightly is permitted in order to insert the product to be dosed into the tank.

! During the calibration phase (test), it is necessary to insert the discharge hose inside the tank.

Connecting hydraulic components on self-purging mod. VMSA MF

Refer to the Figure 9 for the position of the delivery and bleed hoses. The assembly procedure for the suction, delivery and bleed hoses is the same as described above.

Fig. 7. Description of the self-purging pump body.

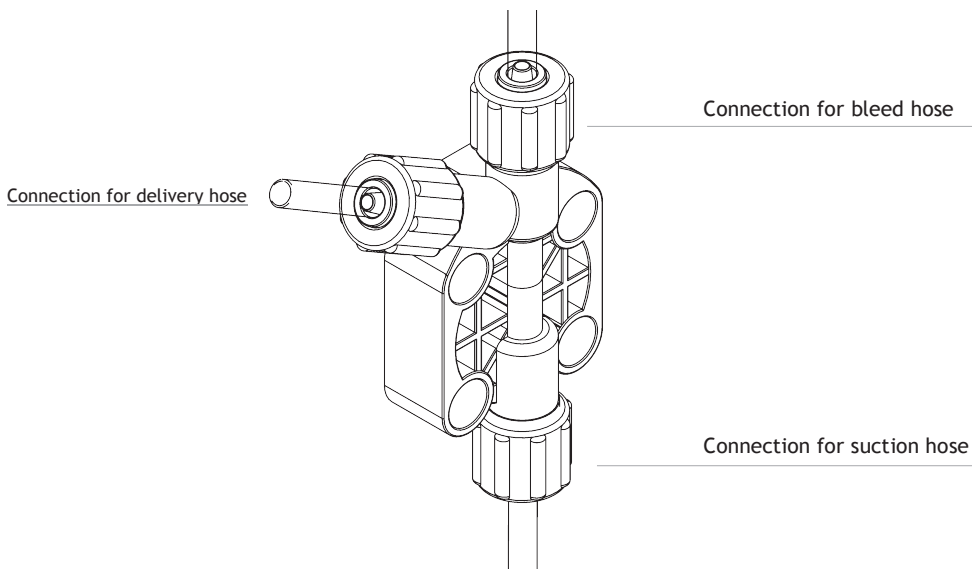

! The suction, delivery and bleed valves are different.

Electrical connection

Preliminary checks

⚠ THE ELECTRICAL CONNECTIONS OF THE PUMP MUST BE CARRIED OUT BY SPECIALISED PERSONNEL.

Before connecting the pump:

1. **Make sure that the values listed on the pump nameplate are compatible with those of the mains.** The pump nameplate is located on the side.
2. **Make sure that the pump is connected to a system with an efficient earth and equipped with a differential with a sensitivity of 0.03A.**
3. **Install a “relay” to prevent damage to the pump. Never install in parallel with inductive loads (e.g. motors). See figure 9.**

Fig. 8. Electrical installation of the pump

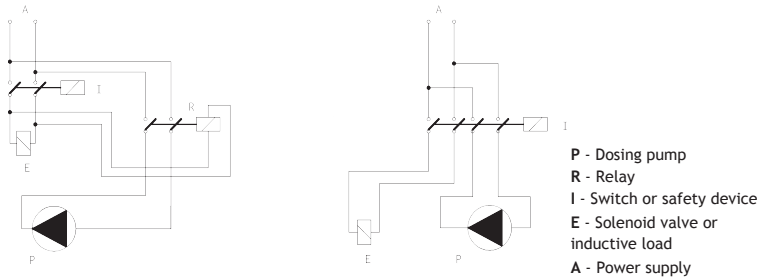

4. **Check the peak absorption. Do not use a motor protector for pumps supplied with 115 or 230 VAC.**

Pump power supply	
12 VDC pump	Connect the pump to a battery of at least 55 Ah-12VDC
24 VDC pump	Connect the pump to a stabilised power supply of at least 200 W (verify peak absorption)

5. **Check that the “BNC” of the level probe has been connected as described in  “Level probe”.**

How to connect the pump

Connect the “BNC” of the external signal to the “INPUT” connector.

SCREEN (CABLE BRAID): -

CENTRAL CONDUCTOR: +

This signal can be used in one of the following modes:

- Meter
- Batch mode start contact
- Voltage input volt mode
- Current input mA
- Stand-by input in Constant mode

Fig. 9. Pump connections

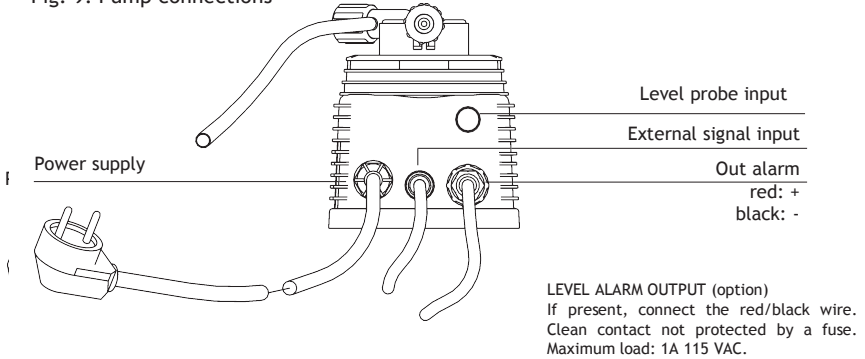

Pulse water meter with HALL effect

The version of the dosing pump for connection to a HALL effect pulse water meter has a 3-wire cable at the external signal input (figure 11).

If the Hall effect pulse water meter is supplied by the manufacturer, the external signal input will have an MPM connector to which to connect the meter.

For connections on the circuit, see  **Circuit diagram**.

Fig. 10. External signal cable for pulse water meter

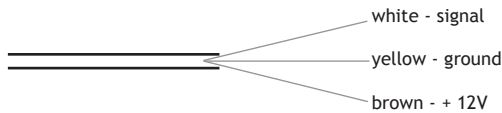

PUMP BODY PRIMING

How to prime
the pump

To prime the pump without coming into contact with the chemical:

1. Connect all hoses (delivery, suction and discharge hose).
2. Open the bleed valve by turning the bleed knob fully.
3. Power the pump. If an activation delay (DELAY) has been set, the display will show a countdown. Press a key to stop the countdown and enter the **MAIN MENU**.
4. Press the key  for 5 seconds.
5. The pump will prime for 30 seconds.
6. When the product begins to circulate within the discharge hose, close the bleed knob (self-purging pump bodies are excluded).
7. When finished, the pump will return to normal operating mode. If you do not wish to wait until the end of the pre-set time (the pump has primed the product) press the “ESC” key.

PUMP PROGRAMMING

Keyboard functions

E	ENTER/EXIT MENU (WITH SAVE)
➡	SCROLL/INCREASE DIGITS
⬆	SCROLL/INCREASE DIGITS
ESC	ON/OFF / EXIT MENU (WITHOUT SAVING)

Table 2. Function of keys

OPERATIONS	KEYS
switch on / switch off	ESC
enter / exit menu	E
save settings	E
exit menu without saving	ESC
set numerical data	⬆
scroll through screens	➡
scroll through options	⬆

Main menu

The main menu provides a summary of the pump's working information:

Table 3. Main menu

STROKES	pulses per minute
UPKEEP ENABLED	upkeep dosing (if set)
MODE	working mode set
SUPPLY	power supply voltage
DOSING	current flow rate of the pump
INPUT (not present in Constant and Batch modes)	external control signal value (Volts and mA) or instantaneous system flow rate (Multiply, Divide and ppm)
STATISTICS	dosing and meter statistics

Table 4. Symbols on the display

#	Signals the presence of an alarm (☹ ALARMS).
---	--

INFO menu

FURTHER INFORMATION ABOUT THE OPERATING STATUS OF THE DOSING PUMP CAN BE VIEWED FROM THE MAIN SCREEN BY PRESSING THE "UP" KEY:

STROKES PER MINUTE SET
 "RECOVERY FAULT" STATUS
 MAINS SUPPLY VOLTAGE
 SET DOSING LITRES/HOUR
 ALARM LEVEL STATUS
 SET WORKING MODE

Entering the programming area

The navigation language must be set when starting the pump for the first time. Use the arrows to scroll and then confirm with ENTER. From the main menu, access programming with key E. The standard protection password is 0000. An ADMIN and USER password can be set. For the first programming or for complete programming choose ADMIN.

The programming menu is divided into three main sub-menus:

- PROG 1 MODE: area for choosing the pump working mode
- PROG 2 SETUP: area for setting working parameters
- PROG 3 STAT: area for overall pump dosing statistics

PROG 1 MODE: Working mode

The pump can be programmed to work in one of the modes shown in Table 6.

Table 5. PROG1 MODE: pump working mode.

MODE	HOW IT WORKS
CONSTANT	The pump doses at a constant frequency in relation to the values of "SPH" (strokes per hour), "SPM" (strokes per minute) or "LPH" (litres per hour) set during programming.
DIVIDE	The pulses supplied by a meter connected to the pump are divided by the value set during programming and determine the dosing frequency.
MULTIPLY	The pulses supplied by a meter connected to the pump are multiplied by the value set during programming and determine the dosing frequency.
PPM	The pulses supplied by a meter connected to the pump determine dosing according to the set PPM value. The concentration of the product dosed, the quantity for each single stroke and the pulse/litre values of the connected meter must be set during programming.
PERC	The pulses supplied by a meter connected to the pump determine dosing according to the set PERC value (%). The concentration of the product dosed, the quantity for each single stroke and the pulse/litre values of the connected meter must be set during programming.
MLQ	The pulses supplied by a meter connected to the pump determine dosing according to the set MLQ (millilitres per quintal) value. The concentration of the product dosed, the quantity for each single stroke and the pulse/litre values of the connected meter must be set during programming.
BATCH	The pulse supplied by an external contact starts dosing the amount of product set during programming.
VOLT	The voltage supplied to the pump (via the input signal) determines proportional dosing according to the two minimum and maximum values in which the strokes per minute were set during programming (0-10 VDC).
mA	The current supplied to the pump (via the input signal) determines proportional dosing according to the two minimum and maximum values in which the strokes per minute were set during programming.
Timer	Weekly programming mode with possibility of repeating up to 16 programs per week and possibility of setting start time, duration, quantity of product to be dosed.

 In the working modes MULTIPLY, DIVIDE, PPM, PERC, MLQ, the pump connected to a pulse meter also becomes an INSTANT FLOW METER.

CONSTANT

The pump doses at a constant frequency in relation to the values of “SPH” (strokes per hour), “SPM” (strokes per minute) or “LPH” (litres per hour) set during programming.

WHEN	In the absence of an external signal, hourly dosing of a product in the desired quantity must be carried out
PARAMETERS	<ul style="list-style-type: none">• SPH (strokes per hour)• SPM (strokes per minute)• CONTACT (for external start-up / stop): disabled, N.O., N.C.• LPH (litres per hour) The accuracy of the LPH depends on the value set in the CC/ST menu (PROG 2 SETUP). The maximum LPH value that can be set depends on the maximum frequency of the pump (refer to the data listed on the nameplate). When a higher value is set, the pump will display the # symbol (ALARM STROKE - (ALARMS)).

Press E on the displayed mode to activate the selection.

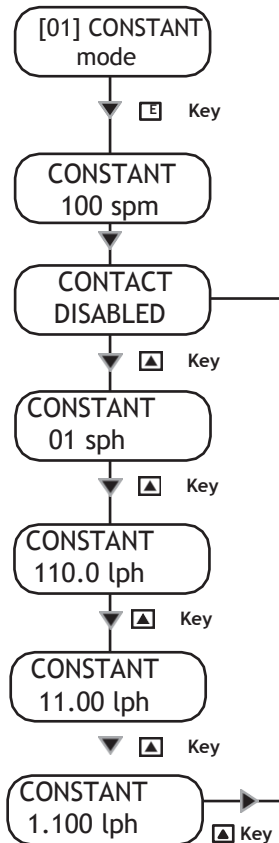

DIVIDE

The pulses supplied by a meter connected to the pump are divided by the value set during programming and determine the dosing frequency.

WHEN	In the presence of an external signal sending too many pulses (small size water meter, e.g. CTFI model), it is necessary to divide them to dose the correct amount of product
PARAMETERS	<ul style="list-style-type: none">DIVIDE (divisor factor). Min value accepted: 001.00.

Fig. 12. Divide menu.

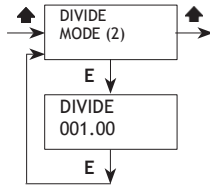

In this working mode, the pump, connected to a pulse water meter, also becomes an INSTANT FLOW METER.

Calculating the division value

Use the formula:

$$\frac{[\text{imp/l}] \times [\text{cc}]}{[\text{ppm}] \times [\text{K}]} \times 1000 = N$$

- N Division value to set
[imp/l] pulses/litre from pulse water meter
[cc] quantity of dosed product per single injection (expressed in cc) of the dosing pump to be used
[ppm] quantity of product to be dosed expressed in parts per million (gr/m³)
[K] dilution coefficient of the product to be dosed.

If N, calculated above, is < 1, it is necessary to install a pulse water meter that delivers a higher number of pulses per litre or a dosing pump with a higher unit flow rate (CC). This problem can be solved by setting the pump to “MULTIPLY” mode and multiplying 1/N. In some particular applications, this can be solved by reducing the dilution factor of the additive to be dosed. If the dosed quantity is greater than required, simply increase the division factor (N) set with the knob on the dosing pump.

MULTIPLY

The pulses supplied by a meter connected to the pump are multiplied by the value set during programming and determine the dosing frequency.

WHEN	In the presence of an external signal sending too little pulses (large size water meter, e.g. CWFA model), it is necessary to multiply them to dose the correct amount of product
PARAMETERS	<ul style="list-style-type: none">• MULTIPLY (multiplication factor). Min value accepted: 001.00.• TIMEOUT (working parameter in PROG 2 SETUP menu)

Fig. 13. Multiply menu.

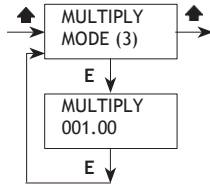

In this working mode, the pump, connected to a pulse water meter, also becomes an INSTANT FLOW METER.

Calculating the multiplication value

Use the formula:

$$\frac{[\text{ppm}] \times [\text{K}]}{[\text{imp/l}] \times [\text{cc}] \times 1000} = N$$

- N Multiplication value to set
[imp/l] pulses/litre from pulse water meter
[cc] quantity of dosed product per single injection (expressed in cc) of the dosing pump to be used
[ppm] quantity of product to be dosed expressed in parts per million (gr/m₃)
[K] dilution coefficient of the product to be dosed.

If N, calculated above, is < 1, it is necessary to install a pulse water meter that delivers a higher number of pulses per litre or a dosing pump with a higher unit flow rate (CC). This problem can be solved by setting the pump to “DIVIDE” mode and dividing 1/N. In some particular applications, this can be solved by reducing the dilution factor of the additive to be dosed. If the dosed quantity is greater than required, simply increase the division factor (N) set with the knob on the dosing pump.

PPM

The pulses supplied by a meter connected to the pump determine the dosage according to the PPM value, product concentration and quantity for each single stroke set during programming.

WHEN	In the presence of an external signal sending pulses, it is necessary to dose the correct amount of product by specifying only the PPM (parts per million) and leaving the pump to manage the incoming pulses
PARAMETERS	<ul style="list-style-type: none">• PPM (quantity of product in parts per million)• CONC (% product concentration)• UPKEEP (maintenance dosing)• WMETER (meter pulses - working parameter in PROG 2 SETUP menu)• CC/ST (cc/pulse- working parameter in PROG 2 SETUP menu)• TIMEOUT (working parameter in PROG 2 SETUP menu)

Fig. 14. PPM menu.

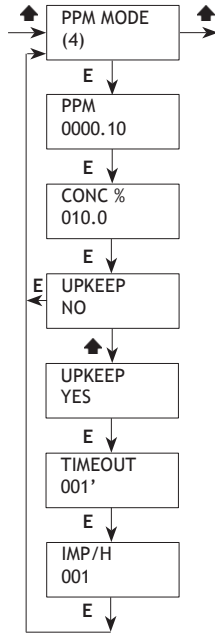

In this working mode, the pump, connected to a pulse water meter, also becomes an **INSTANT FLOW METER**.

Upkeep dosing

In the event of system downtime, the pump can perform upkeep (maintenance) dosing within the circuit.

To activate this function set:

- "UPKEEP YES" (activation of maintenance);
- "TIMEOUT" (time after which, in the absence of pulses, the maintenance dosing must start);
- "IMP/H" (number of pulses/hour that the pump must deliver during maintenance).

PERC

The pulses supplied by a meter connected to the pump determine the dosage according to the PERC (%), product concentration and quantity for each single stroke set during programming.

WHEN	In the presence of an external signal sending pulses, it is necessary to dose the correct amount of product by specifying only the PERC (percentage) and leaving the pump to manage the incoming pulses
PARAMETERS	<ul style="list-style-type: none"> • PERC (quantity of product in percentage) • CONC (% product concentration: 100% pure product) • WMETER (meter pulses - working parameter in PROG 2 SETUP menu) • CC/ST (cc/pulse- working parameter in PROG 2 SETUP menu) • TIMEOUT (working parameter in PROG 2 SETUP menu)

Fig. 15. PERC menu.

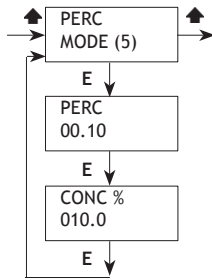

In this working mode, the pump, connected to a pulse water meter, also becomes an **INSTANT FLOW METER**.

Quantity of product be dosed

To calculate the quantity of product be dosed:

$$\frac{\% \text{ product to be dosed} \times \text{system flow rate (l/h)}}{\% \text{ product concentration}}$$

Choosing a water meter

Use a water meter capable of providing the maximum number of pulses possible. Note: maximum frequency for this pump is 1Khz (1000 pulses/second).

MLQ

The pulses supplied by a meter connected to the pump determine the dosage according to the MLQ (millilitres per quintal), product concentration and quantity for each single stroke set during programming.

WHEN	In the presence of an external signal sending pulses, it is necessary to dose the correct amount of product by specifying only the MLQ (millilitres per quintal) and leaving the pump to manage the incoming pulses
PARAMETERS	<ul style="list-style-type: none">• MLQ (quantity of product in millilitres per quintal)• CONC (% product concentration: 100% pure product)• WMETER (meter pulses - working parameter in PROG 2 SETUP menu)• CC/ST (cc/pulse- working parameter in PROG 2 SETUP menu)• TIMEOUT (working parameter in PROG 2 SETUP menu)

Fig. 16. MLQ menu

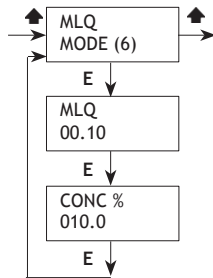

In this working mode, the pump, connected to a pulse water meter, also becomes an **INSTANT FLOW METER**.

BATCH

Pulses supplied from an external contact start the pump according to the strokes required to dose the quantity of product set during programming or for the desired quantity.
 For best result, calibrate the pump carefully (test - PROG 2 SETUP menu).

WHEN	To start the pump for dosing a certain amount of product after receiving a pulse from external equipment
PARAMETERS	<ul style="list-style-type: none"> • MODE (working mode) • CC (quantity of product be dosed) • ST (pulses to be supplied to the magnet) • CONTACT (contact status) • CC/ST (cc/pulse- working parameter in PROG 2 SETUP menu)

Fig. 17. BATCH menu

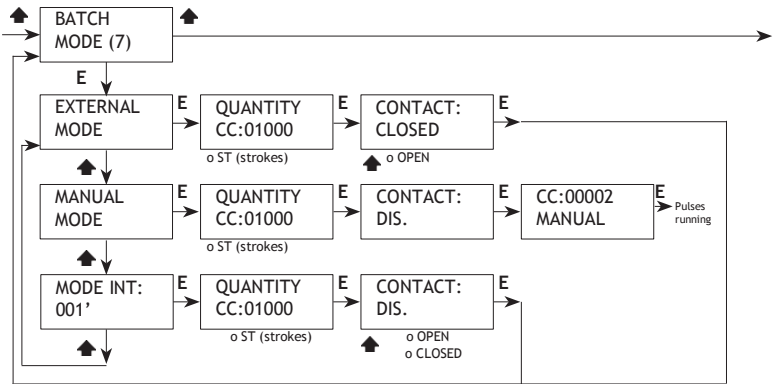

EXTERNAL: an external signal regulates dosing

An external contact (N.O. or N.C.) starts dosing at the maximum frequency (“CC”) or the set number of strokes (“ST”).

EXAMPLE 1

Set as below:



Any change in contact status starts the dosing of the set number of strokes.

Fig. 18. Batch -external mode- contact status and pump working mode



**MANUAL:
manual dosing**

Manual dosing mode used for priming. Set a quantity to dose at maximum frequency (“CC”) or the number of strokes (“ST”). The contact is disabled.

EXAMPLE 2

Set as below:

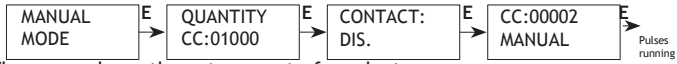

The pump doses the set amount of product.

Fig. 19. Batch -manual mode- pump working mode



**INTERNAL:
pause-work cycle**

In this mode, the dosing activity involves defining the:

- quantity to be dosed at maximum frequency;
- pause time between dosing (“INT”: 1 to 999 minutes).

This establishes a work phase in which there is dosing and a pause phase in which the pump is stopped. The pause-work cycle is determined by the setting of an external contact (N.C.-N.O.). In its set status (N.C. or N.O.), the contact regulates the dosing cycle (pause/work). If it changes status, the pump remains in waiting (WAITING).

If the contact is disabled, the pause/work cycle repeats smoothly as long as the pump is powered.

EXAMPLE 3

Set as below:



The pump doses in a constant pause-work cycle:

Fig. 20. Batch -internal mode- pump working mode with constant pause-work cycle.



EXAMPLE 4

Set as below:



The pump doses in a constant pause-work cycle. Changing the contact status (Open → Closed) stops the cycle.

The cycle always starts in pause mode.

Fig. 22. Batch -internal mode- pump working mode with pause-work cycle regulated by an external contact. Case 1.

The contact changes state during a pump pause phase.
When the contact returns to its previous state, the pump resumes normal operation.

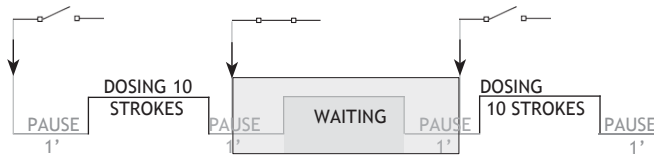
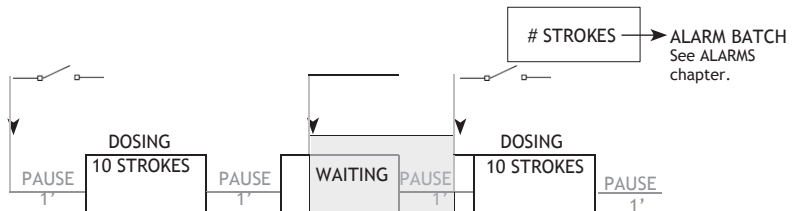

Fig. 21. Batch -internal mode- pump working mode with pause-work cycle regulated by an external contact. Case 2.

The contact changes state during a pump work phase.
When the contact returns to its previous state, the pump resumes normal operation but the display signals a BATCH alarm.



VOLT

The voltage supplied to the pump (via the input signal) determines proportional dosing according to the two minimum and maximum values in which the strokes per minute were set during programming.

WHEN	In the presence of an external voltage signal, it is necessary to dose the correct amount of product.
PARAMETERS	<ul style="list-style-type: none">• HIV (maximum voltage)• LOV (minimum voltage)• SPM (strokes per minute)

Fig. 23. VOLT menu

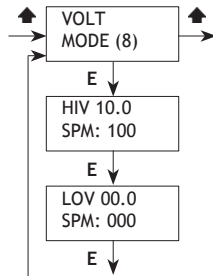

The input signal value (Volts) can be displayed when this mode is set.

Caution: if any setting errors occur (e.g. the same value set for HIV and LOV) a **WRONG ENTRY** error screen will appear. Set the correct parameters.

mA

The current supplied to the pump (via the input signal) determines proportional dosing according to the two minimum and maximum values in which the strokes per minute were set during programming.

WHEN	In the presence of an external current signal, it is necessary to dose the correct amount of product.
PARAMETERS	<ul style="list-style-type: none">• HImA (maximum current)• LOmA (minimum current)• SPM (strokes per minute)

Fig. 24. mA mode

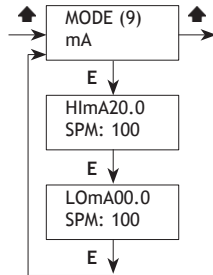

The input signal value (mA) can be displayed when this mode is set.

Caution: if any setting errors occur (e.g. the same value set for HImA and LOmA) a **WRONG ENTRY** error screen will appear. Set the correct parameters.

TIMER

Weekly programming mode with possibility of repeating up to 16 programs per week and possibility of setting start time, duration, quantity of product to be dosed.

WHEN	One or more (max 16) weekly scheduled dosing activities are needed
PARAMETERS	<ul style="list-style-type: none">• Start (start-up time)• Time (duration)• Quantity (quantity be dosed)• Day of the week

This menu defines the settings for the working parameters of the dosing pump.

Table 6. PROG 2 SETUP: parameter setting menu

MENU		PARAMETERS TO BE SET
1	CC/ST	Cubic centimetres per stroke obtained by the Test function (next sub-menu).
2	TEST	Test function for pump calibration: defines the precise cc (cubic centimetres) quantity of the pump.
3	LEVEL	Level pre-alarm (product in reserve).
4	WMETER	When a pulse water meter is installed, enter pulses supplied by the meter.
5	TIMEOUT	Maximum time between one pulse and another within which the pump distributes dosing evenly.
6	UNIT	Pump unit of measurement (litres or gallons).
7	DELAY	Waiting time at pump start-up.
8	PASSWORD	Password setting.
9	FACTORY	Restoring the pump to its factory parameters. Restore.
10	OUT AL	Alarm relays output setup
11	ALARMS	Alarms management
12	LANGUAGE	System Language
13	CLOCK	System Clock

CC/ST

Enter the result of the CC/ST (cubic centimetres/pulse) obtained from the TEST function (next menu) in this sub-menu.

Fig. 25. CC/ST menu

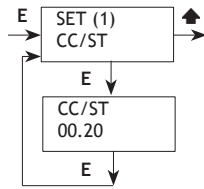

TEST

This test must be carried out in order to define the amount of cc/st (cubic centimetres/pulse) that the pump delivers.

1. Install the pump on the system, taking care to insert the suction hose (complete with foot filter) into a BEKER type test tube graduated in ml (1ml = 1cc). If the pump is of the self-priming type, connect the bleed hose and insert it into the test tube.
2. Power up the pump and turn the single injection adjustment knob to 100%.
3. Fill the graduated test tube to a known value with the product that will be used during normal operation of the system.
4. From the setup menu, select "TEST" and enter as the value of strokes that will be produced: "20".
5. Press "E". The pump will start to produce 20 strokes and suction the liquid into the test tube.
6. When finished, read the amount of liquid left in the test tube on the graduated scale.
7. Subtract the remaining product from the initial product value.
8. Divide the result by the number of strokes delivered by the pump (20).
9. Enter the value in the "CC/ST" menu.
10. If the result obtained is not reliable (values too small or too large), try increasing or decreasing the number of strokes produced by the pump during the "TEST" phase.

Fig. 26. TEST menu

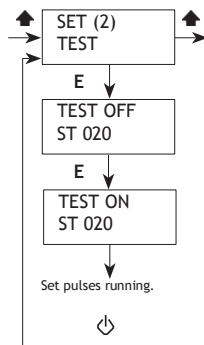

LEVEL

This function defines a **pre-alarm status** warning of the imminent finishing of the product that is being dosed, and which is contained in the sampling tank. The value to be entered must be calculated taking into account the litres or gallons remaining between the level of the foot filter and the suction level of the pump.

Fig. 27. Level pre-alarm.

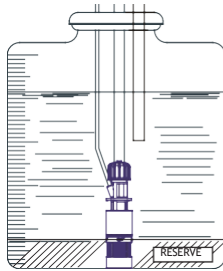

If the pre-alarm is activated, the pump will continue dosing but the symbol # (ALARM LEVEL - ALARMS) will appear on the display.

It is possible to set the type of level contact to N.O. normally open or N.C. normally closed.

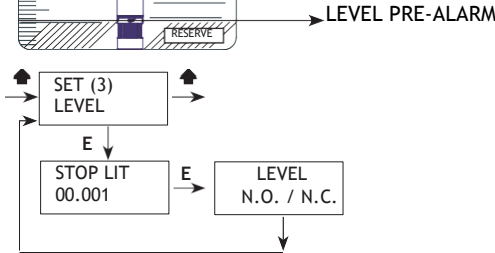

OUT AL

This setting is used to manage the status of the **alarm relay output contact**. The alarm can be enabled as a N.O. (normally open) or N.C. (normally closed) contact.

Fig. 28. Out al menu

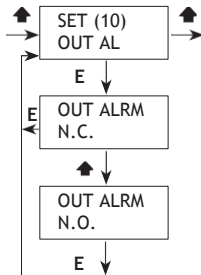

ALARMS

This menu allows you to enable (EN) or disable (DI) the **alarm relay output contact**; with the contact enabled, the relay output changes status in the event of an alarm.

To connect the alarm signal cable **How to connect the pump.**

The relay output can be set for the alarms shown in the table:

Table 7. Events connected to the alarm relay output contact

Alarm		Event
LEV	level	end of product
PPM	ppm	exceeding of working frequency in PPM working mode
PERC	percentage	exceeding of working frequency in PERC working mode
MLQ	mlq	exceeding of working frequency in MLQ working mode
BATCH	batch	In BATCH working mode, a change of contact status interrupts dosing.
OVERFLOW		Work frequency higher than that of the nameplate. Check the set data

WMETER

This menu allows you to set the **characteristics of your pulse water meter**. You can enter the value of pulses supplied by the meter itself, based on which the pump will optimise operation in PPM/MLQ/PERC mode and update the data in the statistics menu.

Choose the pulse/litre ratio if the meter supplies many pulses.

Choose the litre/pulse ratio if the meter supplies few pulses.

If the value is set to 000.0, the pump will not accept the signal and will not allow saving.

Fig. 29. Wmeter menu.

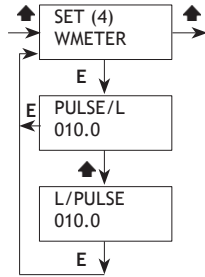

TIMEOUT

In this menu, **set the maximum time that should elapse between one pulse and the next**.

When the pump receives a pulse from the meter, it starts dosing the product by distributing it in the time between the first and the next pulse.

At the first pulse, the pump distributes the amount to be dosed in the shortest possible time. Subsequently, when other pulses arrive, it will distribute the product evenly as it is aware of the time interval between pulses.

Timeout is the maximum time between pulses. Beyond this time, the pump re-initiates dosing, as if it were the first pulse.

The default setting is 120 seconds.

Fig. 30. Timeout menu.

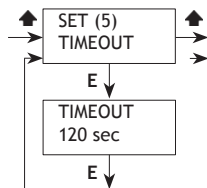

This setting only applies to the MULTIPLY, PPM, PERC and MLQ working modes when the calculation result is a multiplication.

The pulse Timeout does not intervene in DIVIDE mode or in any modes where the result of the calculation is a division.

Fig. 31. Timeout.

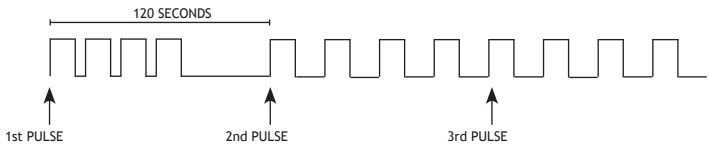

UNIT

Set the **unit of measurement** in litres (LITRE) or gallons (USGAL).

Fig. 32. Unit menu.

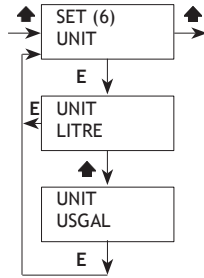

DELAY

This menu lets you set a **waiting time** when powering up the pump.

You can set a time from 0 to 10 minutes.

It is however possible to interrupt this delay by pressing any key to cancel the remaining time.

Fig. 33. Delay menu.

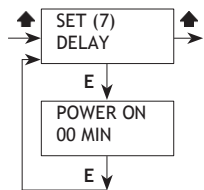

PASSWORD

The password protects the pump's programming menus. The default password is 0000. It is advisable to change it.

If the password is lost, it is necessary to reset the password by means of the **RESET PASSWORD Procedure** described below.

Fig. 34. Password menu.

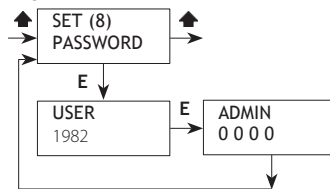

The **USER** password type allows only the working mode set to be changed.

OVERFLOW

This menu lets you set the **overflow**. **ALARM** enables the alarm output (contact 1A 24 VAC) in the event of an overflow. **DELAY** enables the recovery at the end of dosing of pulses received in excess of the target frequency. **STOP** disables the overflow.

Fig. 35. Overflow menu.

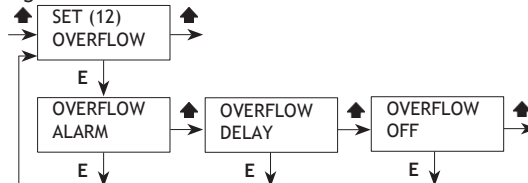

This menu displays the **overall dosing statistics** of the pump, litres of product dosed and number of strokes carried out. All counters can be reset.

Table 8. PROG 3 STAT: statistics menu.

MENU		STATISTICS
1	TOT DOS	Litres of product dosed.
2	COUNTER	Number of pulses carried out.

Fig. 36. Statistics management menu.

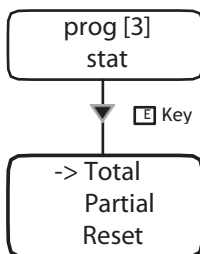

Partial or total statistics for LITRES, m3, l/m3
Reset to zero data (YES)

“TOTAL” indicates product dosed since pump start-up or last reset (DEFAULT).
“PARTIAL” indicates the product dosed since the last reset.

ALARMS

(hashtag) in the main menu indicates the presence of one or more alarms.
To view them, move the arrow \blacktriangle to the ALARM QTY screen: xx.
Enter the sub-menu using the arrow \blacktriangleright

Fig. 37. Active alarms menu.

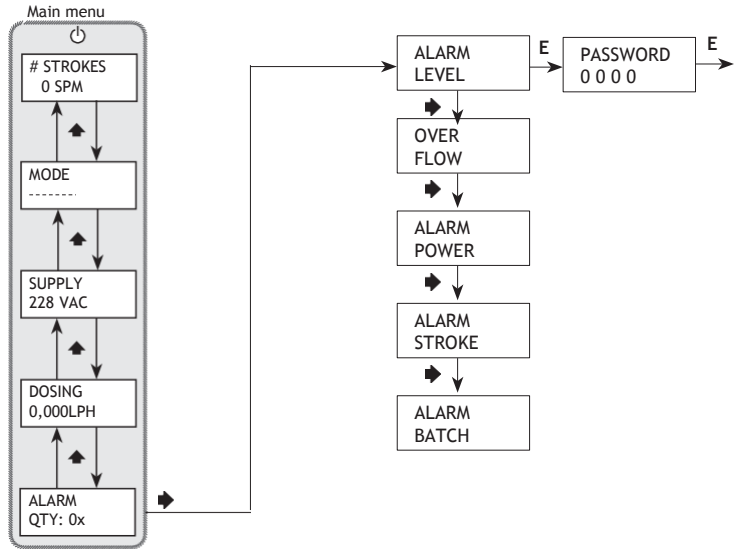

Active windows indicate active alarms.



Table 9. Alarm management

ALARM	PROBLEM	WHAT TO DO
LEVEL	End of product	Refill product
OVER FLOW	Working frequency higher than the frequency listed on the nameplate	Check set data Check pump flow rate Switch the pump off and on again
POWER	Power supply beyond the permitted range	Check that the power supply matches the data listed on the pump nameplate Switch the pump off and on again
STROKE	Pump flow rate higher than the flow rate listed on the nameplate	Check set data Check pump flow rate Switch the pump off and on again
BATCH	Dosing interruption due to change of contact status (Batch mode)	Check correspondence between the supplied contact and the pump setting Switch the pump off and on again

Note: The symbol “#” appears on the display in the event of an alarm during normal operation!

TROUBLESHOOTING

Table 10. Troubleshooting.

PROBLEM	CAUSE	WHAT TO DO
The pump does not switch on	<ul style="list-style-type: none"> • There is no power supply. • Protection fuse blown • Faulty circuit 	<ul style="list-style-type: none"> • Connect the pump to the mains • Replace the fuse following  Fuse replacement procedure. • Replace the circuit following  Circuit replacement procedure.
The pump is not dosing but the magnet is working	<ul style="list-style-type: none"> • Foot filter obstructed • Unprimed pump (suction hose empty) • Air bubbles in the hydraulic circuit • Product used generates gas 	<ul style="list-style-type: none"> • Clean the foot filter • Perform the priming procedure • Check fittings and hoses and drain air inside • Open the bleed tap to let the air vent out. Replace the pump body with a self-purging model
The pump is not dosing and the magnet is not working or the stroke is severely attenuated	<ul style="list-style-type: none"> • Crystal formation is blocking the balls • Injection valve obstructed 	<ul style="list-style-type: none"> • Clean the valves and try circulating 2-3 litres of water instead of the chemical • Replace valves
Pump displays ERROR MEM	Data storage error	Reset to default values by following the  RESET procedure.
Pump displays ERROR DATA	Data entry error	Check the values entered. If correct and the error is still displayed, the pump may be undersized
Invalid password	Ask for technical support	
Pump displays INPUT OPEN	Only in mA or Volt working mode: no input signal	Check pump INPUT (external signal)

PUMP RESET procedure

This operation results in the total deletion of the programming data (Ⓜ **Default parameters**). Alternatively, press all keys while disconnecting and reconnecting the pump to the power supply. Proceed as follows:

- Choose “FULL MENU” from the main screen.
- Scroll to the “SETUP” item and then select “FACTORY”.
- Select “YES” and then confirm.

Fuse replacement procedure

This operation must be carried out by **qualified technical personnel**.

Fuse replacement requires two 3x16 and 3x15 Phillips screwdrivers and a fuse identical to the type of the blown one.

Proceed as follows:

- Disconnect the pump from the mains and the hydraulic system.
- Remove the screws at the rear of the pump.
- Remove the rear part of the pump until it is completely detached from the front part, however until the circuit located on the front part of the pump is accessible. Take care with the spring located on the axis of the injection knob.
- Locate the fuse and replace with one of EQUAL value.
- Taking care with the spring between the magnet and the injection knob axis, reinsert the rear part of the pump until complete contact is made with the front part.
- Tighten the screws on the pump.

FUSE VALUES	
Solenoid diam.	100 - 240 VAC
60	800mA
70	
80	

Circuit replacement procedure

This operation must be carried out by **qualified technical personnel**.

Fuse replacement requires two 3x16 and 3x15 Phillips screwdrivers and a circuit with the same electrical characteristics (power supply) as the one to be replaced. Proceed as follows:

- Disconnect the pump from the mains and the hydraulic system.
- Remove the screws at the rear of the pump.
- Remove the rear part of the pump until it is completely detached from the front part and disconnect all wires connected to the circuit. Take care with the spring located on the axis of the injection knob.
- Remove the screws securing the circuit.
- Replace the circuit after noting the position of the wires (see Ⓜ **Circuit diagram**) and secure the circuit to the pump by tightening the fixing screws.
- Taking care with the spring between the magnet and the injection knob axis, reinsert the rear part of the pump until complete contact is made with the front part.
- Tighten the screws on the pump.

Fig. 38. VMS MF / VMSA MF circuit diagram

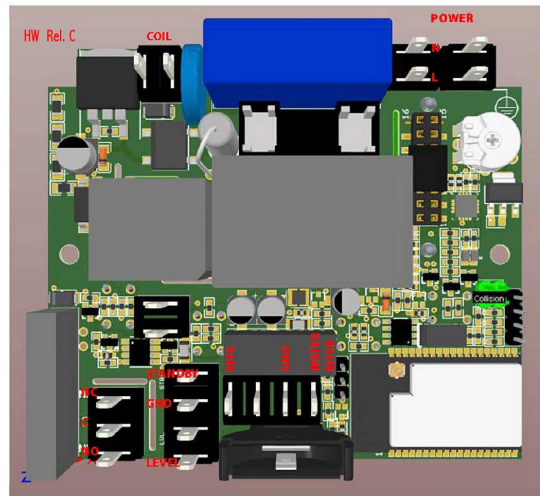
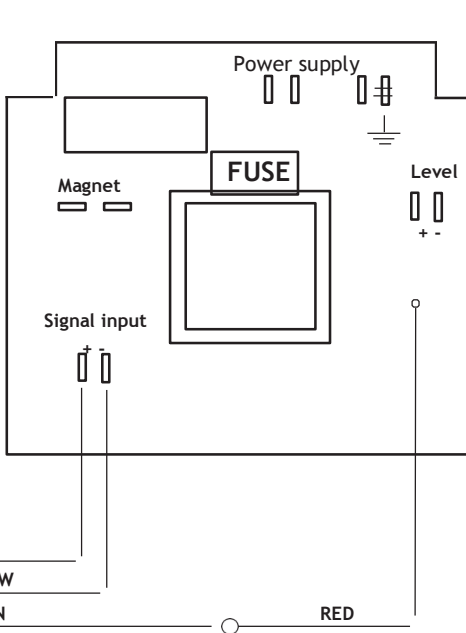
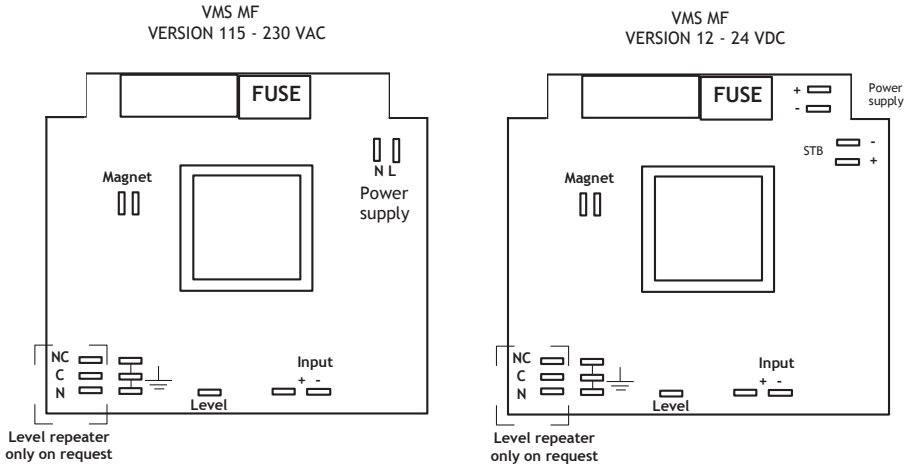

Fig. 39. VMS MF circuit diagram for connection to a pulse water meter with Hall effect

Maintenance planning

⚠ In order to guarantee the potability requirements of the treated drinking water and the maintaining of the improvements as stated by the manufacturer, this equipment must be checked AT LEAST once a month.

⚠ **OPERATOR PROTECTION**
ALWAYS wear safety equipment in accordance with company regulations. In the work area, during installation, maintenance and while handling chemicals use:

- Protective mask
- Protective gloves
- Safety goggles
- Ear plugs or headphones
- Additional PPE, if required

⚠ Always turn the power off before performing any installation or maintenance work. Failure to turn off the power supply could result in serious bodily injury.

⚠ All service work should only be carried out by experienced and authorised personnel.
Always use original spare parts.

Maintenance inspections

Maintenance planning includes the following types of inspection:

- Routine maintenance and inspections
- Quarterly inspections
- Annual inspections

If the pumped liquid is abrasive or corrosive, shorten the inspection intervals appropriately.

Routine maintenance and inspections

Carry out the following operations when performing routine maintenance:

- Check the mechanical seal and make sure there are no leaks.
- Check electrical connections.
- Check for unusual noises, vibrations (noise must not exceed the dbA stated in the manual).
- Check for leaks in the pump and hoses.
- Check for corrosion on pump parts and/or hoses.

Quarterly inspections

Perform the following operations every three months:

- Check that fixing is stable.
- If the pump has been idle, check the mechanical seal and replace if necessary.

Annual inspections

Carry out the following operations once a year:

- Check the pump capacity (must match the capacity listed on the nameplate).
- Check the pump pressure (must match the pressure listed on the nameplate).
- Check the pump performance (must match the performance listed on the nameplate).

If the performance of the pump does not meet the process requirements, and these requirements have remained unchanged, carry out the following steps:

1. Dismantle the pump.
2. Inspect the pump.
3. Replace worn parts.

Flow rate curves

All flow rate indications refer to measurements made with H₂O at 20 °C at the indicated back pressure.

The dosing accuracy is ± 2% at a constant pressure of ± 0.5 bar.

Fig. 40. VMS MF flow rate curves

2001: l/h 1 bar 20
Pump body mod. J

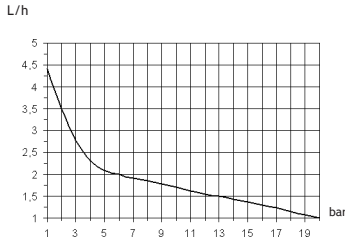

1804: l/h 4 bar 18
Pump body mod. K



1802: l/h 2 bar 18
Pump body mod. K

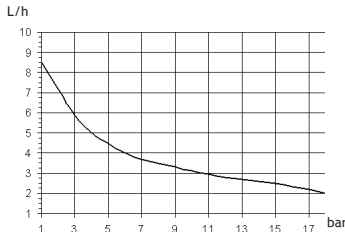

1504: l/h 4 bar 15
Pump body mod. K

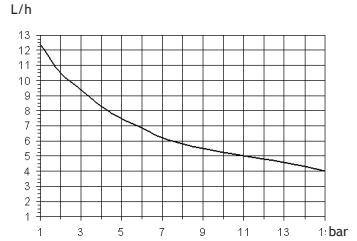

1502: l/h 2 bar 15
Pump body mod. K



1010: l/h 10 bar 10
Pump body mod. K

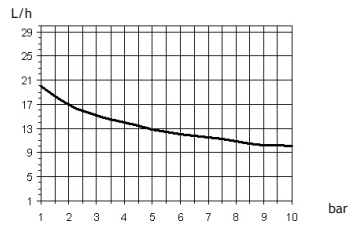

1005: l/h 5 bar 10
Pump body mod. K

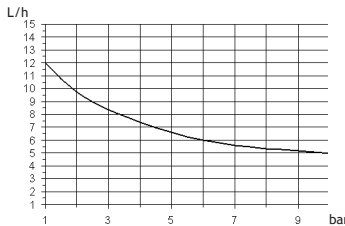

1004: l/h 4 bar 10
Pump body mod. K

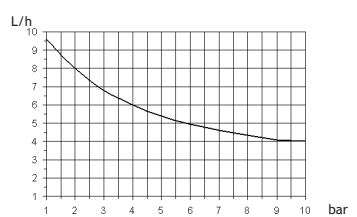

0706: l/h 6 bar 7
Pump body mod. K

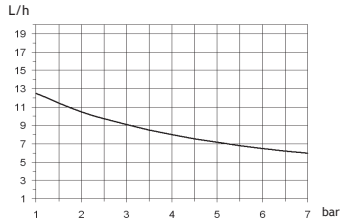

0510: l/h 10 bar 5
Pump body mod. K

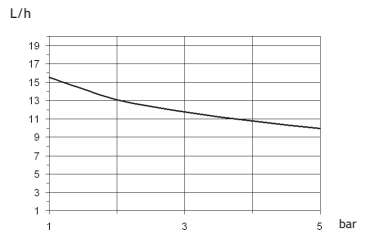

0501: l/h 1 bar 5
Pump body mod. J

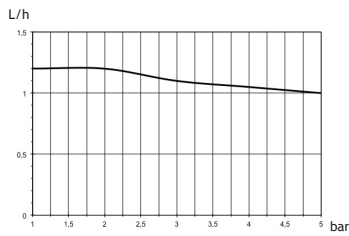

0512: l/h 12 bar 5
Pump body mod. K

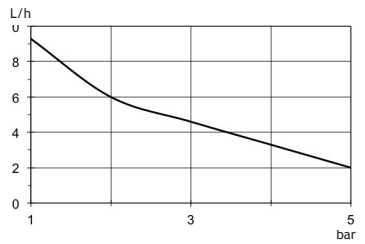

0408: l/h 8 bar 4
Pump body mod. K

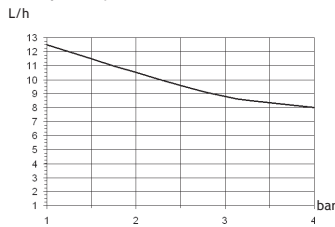

0310: l/h 10 bar 3
Pump body mod. K

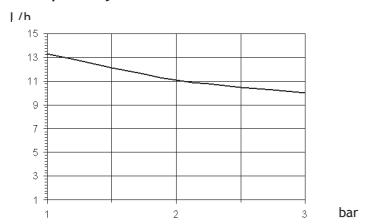

0215: l/h 15 bar 2
Pump body mod. K

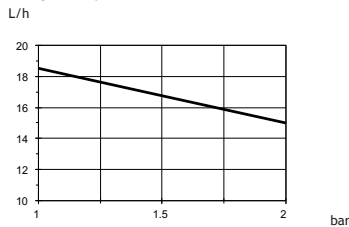

0116: l/h 16 bar 1
Pump body mod. K

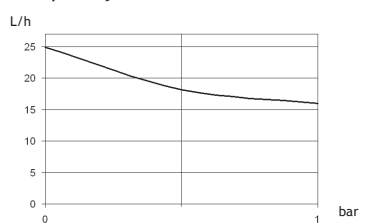
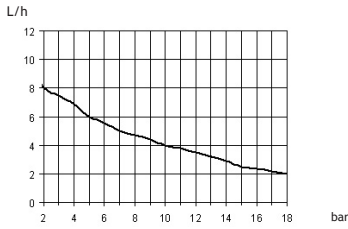

Fig. 41. VMSA MF flow rate curves

1802: l/h 2 bar 18
Pump body mod. KA



1503: l/h 3 bar 15
Pump body mod. KA



1501: l/h 1 bar 15
Pump body mod. KA

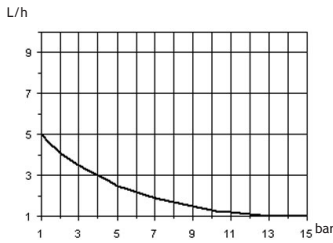

103.4: l/h 3.4 bar 10
Pump body mod. KA

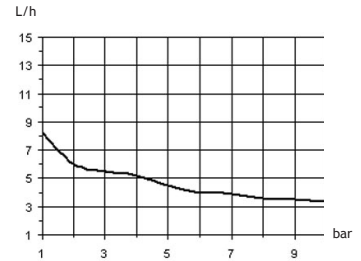

1002: l/h 2 bar 10
Pump body mod. KA

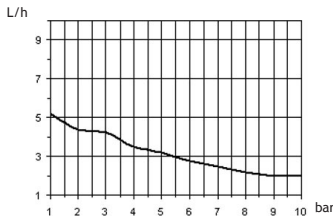

0704: l/h 4 bar 7
Pump body mod. KA

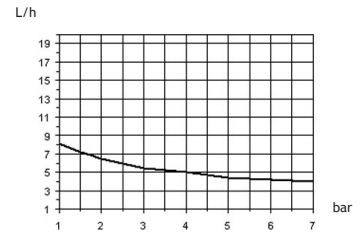

057.5: l/h 7.5 bar 5
Pump body mod. KA



045.5: l/h 5.5 bar 4
Pump body mod. KA

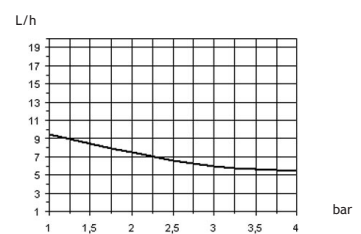

0307: l/h 7 bar 3
Pump body mod. KA

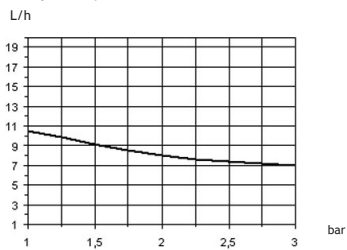

Dimensions

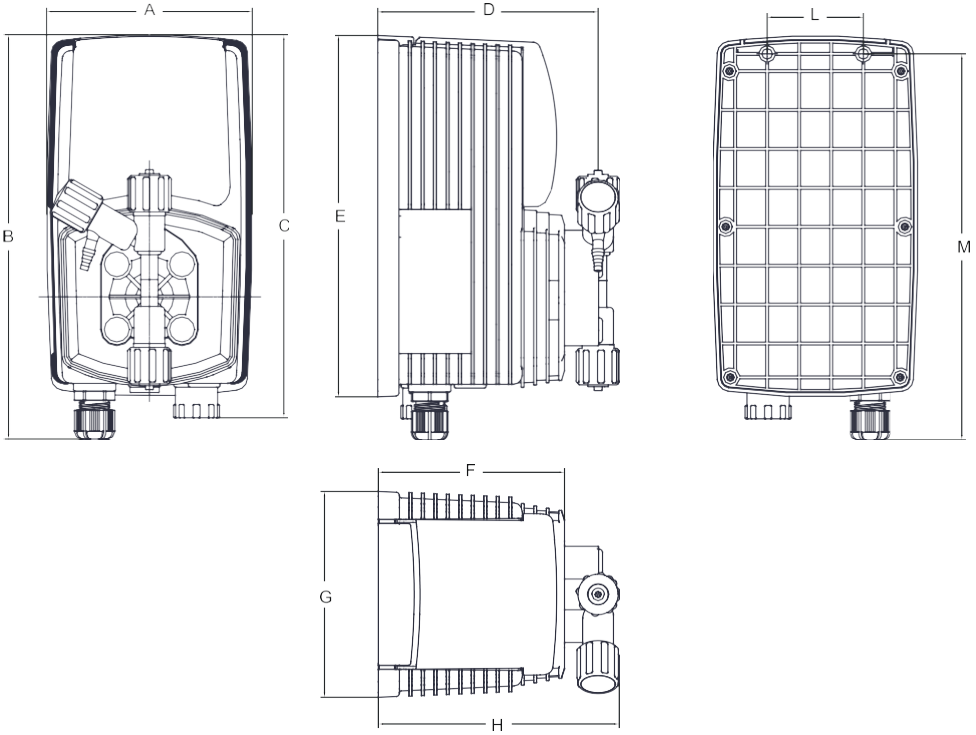

DIMENSIONS		
	<i>mm</i>	<i>inch</i>
<i>A</i>	106.96	4.21
<i>B</i>	210.44	8.28
<i>C</i>	199.44	7.85
<i>D</i>	114.50	4.50
<i>E</i>	187.96	7.40
<i>F</i>	97.00	3.81
<i>G</i>	106.96	4.21
<i>H</i>	125.47	4.93
<i>L</i>	50.00	1.96
<i>M</i>	201.00	7.91

Chemical compatibility table

Dosing pumps are widely used for dosing chemical products. Select the most suitable material for the liquid to be dosed in the CHEMICAL COMPATIBILITY TABLE. The information in the table is checked periodically and believed to be correct at the date of publication. The data contained in the table are based on information provided by the manufacturers and their experience, but as the resistance of materials depends on many factors; this table is provided as an initial guide only. The manufacturer accepts no responsibility for the contents of the table.

Table 11. Chemical compatibility table.

Product	Formula	Ceram.	PVDF	PP	PVC	SS 316	PMMA	Hastel.	PTFE	FPM	EPDM	NBR	PE
Acetic Acid, Max 75%	CH3COOH	2	1	1	1	1	3	1	1	3	1	3	1
Concentrated hydrochloric acid	HCl	1	1	1	1	3	1	1	1	1	3	3	1
Hydrofluoric acid 40%	H2F2	3	1	3	2	3	3	2	1	1	3	3	1
Phosphoric acid, 50%	H3PO4	1	1	1	1	2	1	1	1	1	1	3	1
Nitric acid, 65%	HNO3	1	1	2	3	2	3	1	1	1	3	3	2
Sulphuric acid 85%	H2SO4	1	1	1	1	2	3	1	1	1	3	3	1
Sulphuric acid 98.5%	H2SO4	1	1	3	3	3	3	1	1	1	3	3	3
Amines	R-NH2	1	2	1	3	1	-	1	1	3	3	1	1
Sodium bisulphate	NaHSO3	1	1	1	1	2	1	1	1	1	1	1	1
Sodium carbonate (Soda)	Na2CO3	2	1	1	1	1	1	1	1	2	1	1	1
Ferric chloride	FeCl3	1	1	1	1	3	1	1	1	1	1	1	1
Calcium hydroxide	Ca(OH)2	1	1	1	1	1	1	1	1	1	1	1	1
Sodium hydroxide (Caustic soda)	NaOH	2	3	1	1	1	1	1	1	2	1	2	1
Calcium hypochlorite	Ca(OCl)2	1	1	1	1	3	1	1	1	1	1	3	1
Sodium hypochlorite, 12.5%	NaOCl + NaCl	1	1	2	1	3	1	1	1	1	1	2	3
Potassium permanganate 10%	KMnO4	1	1	1	1	1	1	1	1	1	1	3	1
Hydrogen peroxide, 30%	H2O2	1	1	1	1	1	3	1	1	1	3	3	1
Aluminium sulphate	Al2(SO4)3	1	1	1	1	1	1	1	1	1	1	1	1
Copper sulphate	CuSO4	1	1	1	1	1	1	1	1	1	1	1	1

1 - Component with very good resistance

2 - Component with moderate resistance

3- Component with no resistance

Pump manufacturing materials

- Polyvinylidene fluoride (PVDF)..... Pump bodies, valves, fittings, hoses
- Polypropylene (PP)..... Pump bodies, valves, fittings, floater
- PVC Pump bodies
- Stainless steel (SS 316) Pump bodies, valves
- Polymethyl Metacrilate Acrylic (PMMA) ... Pump bodies
- Hastelloy C-276 (Hastelloy)..... Injection valve spring
- Polytetrafluoroethylene (PTFE)..... Diaphragm
- Fluorocarbon (FPM) Seals
- Ethylene propylene (EPDM) Seals
- Nitrile (NBR)..... Seals
- Polyethylene (PE) Hoses

The technical characteristics of the hoses are of essential importance for accurate and safe dosing.

Each pump model is supplied by the manufacturer for optimal functioning of the hydraulic connections according to dosing capacity.

The information in the table is checked periodically and believed to be correct at the date of publication. The data contained in the table are based on information provided by the manufacturers and their experience, but as the resistance of materials depends on many factors; this table is provided as an initial guide only. The manufacturer accepts no responsibility for the contents of the table.

Table 12. Hose characteristics

Tubo aspirazione / scarico			
4x6 mm PVC (trasparente)	4x8 mm PE (opaco)	6x8 mm PE (opaco)	8x12 mm PVC (trasparente)

Tubo mandata	Pressione di esercizio				Pressione di scoppio			
4x6 mm PE 230 (opaco)	20°C 12 bar	30°C 10.5 bar	40°C 8.5 bar	50°C 6.2 bar	20°C 36 bar	30°C 31.5 bar	40°C 25.5 bar	50°C 18.5 bar
4x8 mm PE 230 (opaco)	20°C 19 bar	30°C 15.7 bar	40°C 12 bar	50°C 7.5 bar	20°C 57 bar	30°C 47 bar	40°C 36 bar	50°C 22.5 bar
6x8 mm PE 230 (opaco)	20°C 8.6 bar	30°C 6.8 bar	40°C 4.8 bar	50°C 2.3 bar	20°C 26 bar	30°C 20.5 bar	40°C 14.5 bar	50°C 7 bar
8x12 mm PE 230 (opaco)	20°C 12 bar	30°C 10.5 bar	40°C 8.5 bar	50°C 6.2 bar	20°C 36 bar	30°C 31.5 bar	40°C 25.5 bar	50°C 18.5 bar
4x6 mm PVDF Flex 2800 (opaco)	20°C 40 bar	30°C 34 bar	40°C 30 bar	50°C 27 bar	60°C 24.8 bar	80°C 20 bar	90°C 10 bar	
6x8 mm PVDF Flex 2800 (opaco)	20°C 29 bar	30°C 25.5 bar	40°C 22 bar	50°C 20 bar	60°C 18 bar	80°C 14.5 bar	90°C 7.3 bar	
8X10 mm PVDF Flex 2800 (opaco)	20°C 18 bar	30°C 15.5 bar	40°C 13.5 bar	50°C 12.5 bar	60°C 11.2 bar	80°C 9 bar	90°C 4.5 bar	
1/4 PE 230 (opaco)	20°C 17.6 bar							
3/8 PE 230 (opaco)	20°C 10.6 bar							
1/2 PE 230 (opaco)	20°C 10.6 bar							

Fig. 42. Exploded view of VMS MF pump

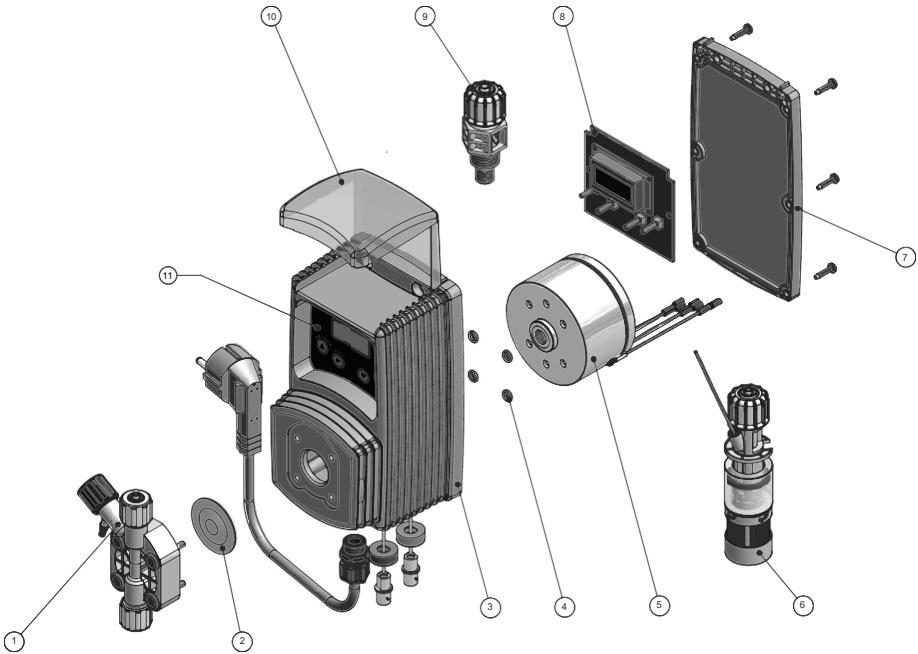

TECHNICAL FEATURES

Power supply:	100 - 240VAC (50/60 Hz)
Pump Strokes:	0 - 180
Suction Height:	1.5 metres (4.9 Feet)
Environment Temperature:	0 - 45 °C (32 - 113 °F)
Chemical Temperature:	0 - 50 °C (32 - 122 °F)
Installation Class:	II
Pollution Level:	2
Audible Noise:	70.4 db(A)
Packaging and Transporting Temperature:	-10 - 50 °C (14 - 122 °F)
Protection degree:	IP65
Max operating altitude:	2000mt (6561.68 Feet)
Max relative humidity (non condensing):	95%
Net Weight:	1.5 Kg (3.3 lb)

MANUFACTURING MATERIALS

REPAIR REPORT

ENCLOSE THIS COMPLETED AND SIGNED FORM WITH THE TRANSPORT DOCUMENT

DATE

SENDER

Company name.....
Address
Telephone
Contact person

PRODUCT (see pump label)

CODE
S/N (serial number)

OPERATING CONDITIONS

Installation location/description
.....
Chemical dosed
Start-up (date) Running time (approx.)
Remove all liquid inside the pump body and dry it BEFORE packing it in its original box.

DESCRIPTION OF DEFECT

MECHANICAL
Worn parts
Breakage or other damage
Corrosion
Other

ELECTRICAL
Connections, connector, cables
Controls (keyboard, display, etc.)
Electronics
Other

LEAKS
Connections
Pump body.....

INADEQUATE OPERATION/MALFUNCTION/OTHER
.....
.....

I declare that the product is free of any hazardous, biological or radioactive chemicals.

Signature of person compiling information

Company stamp

SUMMARY

GENERAL NOTES ON SAFETY	2
INTRODUCTION	6
VMS MF series	6
VMSA MF series	6
Package contents	6
Technical and electrical specifications	8
Manufacturing materials	10
Default parameters	10
INSTALLATION	11
Installing the dosing pump	11
Pump positioning	11
HYDRAULIC CONNECTION	13
Level probe	13
Suction hose / foot filter connection	14
Delivery hose / pump body assembly	14
Injection valve	15
Bleed hose	15
Connecting hydraulic components on self-purging mod. VMSA MF	16
ELECTRICAL CONNECTION	17
Preliminary checks	17
How to connect the pump	18
Pulse water meter with HALL effect	18
PUMP BODY PRIMING	19
How to prime the pump	19
PUMP PROGRAMMING	20
Keyboard functions	20
Main menu	20
Entering the programming area	21
PROG 1 MODE: Working mode	21
CONSTANT	22
DIVIDE	23
Calculating the division value	23
MULTIPLY	24
Calculating the multiplication value	24
PPM	25
Upkeep dosing	25
PERC	26
Quantity of product be dosed	26
Choosing a water meter	26
MLQ	27
BATCH	28
EXTERNAL: an external signal regulates dosing	28
MANUAL: manual dosing	29
INTERNAL: pause-work cycle	29
VOLT	31
mA	32
PROG 2 SETUP: Working settings	33
cc/st	34
TEST	34
level	35
WMETER	36
TIMEOUT	36
UNIT	37
DELAY	37
PASSWORD	37
PROG 3 STAT: Statistics	38
ALARMS	39

TROUBLESHOOTING 40

RESET procedure	41
Fuse replacement procedure	41
Circuit replacement procedure	41
Circuit diagram	42
Maintenance planning	43
Maintenance inspections	43
Flow rate curves	44
Dimensions	48
Chemical compatibility table	49
Pump construction materials	49
Hose characteristics	50



Disposal of end-of-life equipment by users

This symbol warns against disposing of the product with normal waste. Respect human health and the environment by delivering the discarded equipment to a designated collection point for the recycling of electronic and electrical equipment. For further information please visit the online site.



All materials used in the construction of the dosing pump and for this manual can be recycled and thus help to preserve the incalculable environmental resources of our Planet. Do not dispose of harmful materials in the environment! Enquire with the relevant authority about recycling programs for your area!